

Military Architecture in Tiznit–Morocco: Walls as a model**Dr. Amer AGLAN**

Teacher, Islamic Archaeology dept., Faculty of Archaeology, Sohag Univ., Egypt.

ameraglan@arch.sohag.edu.eg**Abstract:**

Cities in the countries of the Maghreb and Andalusia preserved a huge heritage of forts, kasbahs, castles and walls that truly indicate the great role they played. Military fortifications were not just buildings that were called for by war events at that time only, but rather these facilities represented a lifestyle that affected the lives of societies and their facilities and in the formation of the city in general. Rulers sought to fortify cities to keep the entity of the country and establishing its authority and to protect the city and its urban development, hence various fortifications and military architecture like forts, castles, walls, towers and many others were built, so every city or village, whether in Morocco or Andalusia, almost had a wall surrounding its buildings to protect it, as well as a Kasbah, castle or fort that acted as a second line of defense for it. Which was applied to the city of Tiznit which had a great importance in the Alawite Age; so Sultan Hassan had fortified it and built its walls to be turned from a mere tiny village into a city and a center of the authority in the Souss region, in the south of Morocco. In this context, this article aims to highlight the city walls by checking out the date of building the walls, the reasons for their building, the used building materials. This article also aims for description and analysis of the walls and making plans and projections, horizontal and vertical sections and extracting its architectural elements to highlight its historical, architectural and cultural significances. Bearing in mind the culture of the era in which those walls were built, from political, social and economic conditions, also climatic and topographical conditions. The paper concludes with a recommendation to protect and to invest it as well, especially as they are the last walls built in Morocco.

Key Words:

Cities, Walls, Military Architecture, Tiznit, Morocco.

المخلص:

تحتفظ المدن في بلاد المغرب والأندلس في وقتنا هذا بتراث ضخم من الحصون والقصاب والقلاع والأسوار التي تنطق حقاً بالدور الكبير الذي قامت به، ولم تكن الاستحكامات الحربية مجرد مبانٍ دعت لإنشائها الأحداث في ذلك الوقت وحسب، بل مثلت تلك المنشآت نمط معيشة أثر في حياة المجتمعات ومنشآتهم وفي تكوين المدينة بشكل عام. فالتحصين هو الذي أعطى المدينة العربية والإسلامية المحصنة كثيراً من ملامحها العامة ومقوماتها الرئيسية. وقد سعى الحكام لتحصين المدن للحفاظ على كيان الدولة وترسيخ سلطتها. ولحماية المدينة وتنمية عمرانها أنشئت التحصينات والاستحكامات الحربية المتنوعة من حصون وقلاع وأسوار وأبراج وغيرها. فالأمن والأمان يمثل قيمة أساسية لنشأة المجتمع الحضري المستقر، وجدير بالذكر أنه كان لكل مدينة أو قرية سواء في المغرب أو الأندلس تقريباً سور يحيط بعمرانها لحمايتها، فضلاً عن قسبة أو قلعة أو حصن تعمل كخط دفاع ثانٍ عنها. وهو ما انطبق على مدينة تيزنيت التي أصبح لها أهمية كبيرة في العصر العلوي، لذلك قام السلطان الحسن الأول بتحسينها وبناء أسوارها لتتحول من مجرد قرية صغيرة إلى مدينة ومركز للسلطة في منطقة سوس جنوب المغرب.

وفي هذا السياق تهدف هذه المقالة إلى إلقاء الضوء على أسوار المدينة من خلال تحقيق تاريخ إنشاء الأسوار، وأسباب بنائها، وتمويل البناء، ومواد البناء. كما تهدف الدراسة إلى توثيق الأسوار، وتحليل عناصرها المعمارية، وعمل مخططات ومساقط وقطاعات رأسية وأفقية وتفریغات لعناصرها المعمارية؛ بهدف إبراز أهميتها التاريخية والمعمارية والحضارية، واضعة في الاعتبار ثقافة العصر الذي أنشئت فيه تلك الأسوار، من ظروف سياسية واجتماعية واقتصادية، وظروف مناخية وطبوغرافية، مثلت جميعاً الإطار الذي كان يعمل في ظله المعمار المسلم. وتوصي الدراسة بالحفاظ على الأسوار خاصة وأنها آخر أسوار بنيت في بلاد المغرب.

الكلمات المفتاحية :

مدن، الأسوار، العمارة الحربية، تيزنيت، المغرب

Introduction:

Tiznit is one of the towns in the south of Morocco region of Souss-Massa, it's the capital of Tiznit province. It is bordered by *Chtouka Aït Baha* province to the north, *Guelmim* and *Sidi Ifni* to the south, *Tata* and *Taroudant* to the east, and to the west is the Atlantic Ocean (Map 1). Tiznit arose in a plain known as "Azgar" and its Tamazight idiom means plain or every flat place compared to other high nearby places. This plain is characterized by flatness and low height. Good to mention that Tiznit plain, there is underground waters and it contains a lot of water holes. The city of Tiznit was established on a spring of water known as the old eye or blue eye⁽¹⁾ *Azgedium*, and . The rise of the city was linked to the water element in this dry m⁽²⁾ became famous for herding activity. It seems that this phenomenon was the basis for the stability of groups coming from the mountains towards *Azgar* plain after discovering the water holes⁽²⁾ The name of Tiznit hasn't been mentioned in the sources of the middle ages or in Travelers' books, even *Al-Hassan Al-wazzan* didn't mention it in his description of towns and villages of Souss. However *Azgar* plain has never been empty by any way, the region witnessed the increase of the ancient human emigrations because its lands were suitable for pasture, agriculture and waterholes⁽³⁾ (This plain which is a natural extension of Souss was a traffic area³⁾ for human groups which were moving towards the desert in the south or moving in the directions of the area located in the north of "*Walvas Valley*", whether these moves are in commercial, military or herding context⁽⁴⁾, *Aït Tiznit* ring of Tiznit tribal stability (. There were previous⁽⁴⁾ however their news was triggered by the rapid events in Souss region in the age of *Marinids* whose authority remained on Souss region and it was influx from (668 AH /1269 AD) until the death of Sultan *Yaqoub ibn Abd al-Haqq* (685AH / 1286 AD). They had to send military campaigns every now and then to ensure establishment of security in this region in which the revolution of *Bani Yader* never calmed down on one hand, and the domineering of *Arab Alma'kel* and their control over the road on the other hand⁽⁵⁾ (in *Abo Anan*. After the death Sultan⁽⁵⁾ (759 AH/ 1357 AD) the influence of *Marinades* was reduced from Souss as a final result, and the city entered a new era of chaos and turmoil. However, the region of *Azgar* witnessed an increased movement and stability of the tribes in the age of *Marinades*⁽⁶⁾ (the *Marinids*After⁽⁶⁾ disturbances remained striking the region especially since *Bani Wattas* were unable to extend their control towards Souss, because their authority was shrinking at times to be limited to the city of Fes and its environs, therefore Souss remained far from any central authority and suffered a lot from the submission to the Arab tribals' influence, as they extended their authority towards the plains and imposed many taxes on the population against the trade routes security⁽⁷⁾

In the age of *Sharifian Saadis* the interest in Souss region increased, they renovated the city of Taroudant and made it a fortified base in that region facing the Spanish and Portuguese occupation of Souss and Morocco coasts in general^(٨), tribes continued to increase and settle^(٩) in the region because of its security and stability in the *Saadi* era which considered the land of Sous money house, and they sold spots to whoever wanted to buy lands, Sultan *Aḥmad al-Mansūr* also imposed annual taxes according to the number of *alserouj* and *alkawanin*^(٩). The^(٩) feature of the reconstruction of the plain of Souss are illustrated in what *Al-Saktani* mentioned, that tribes went to exploit the lands of *Azgar* to cultivate and revive the waterholes^(١٠) information indicates that the region began to know distinguished stability, its habitants seemed more attached to the land, therefore it is not a coincidence that the first indications returned to Tiznit was prominent on the scene many times as a base for the royal campaigns that targeted the southern part of Souss plain, that's why it was chosen as one of the campaigns bases of Sultan *Aḥmad al-Mansūr*^(١١).

However, things changed at the end of the *Saadi* State. As the region became a scene for political disturbances and instability after the death of Sultan *Aḥmad al-Mansūr* (1012 AH /1603 AD). This situation continued in the *Alawite* age which made Sultans sending campaigns to extend their control and for security to stabilize in the region. During the region of Sultan *Suleiman* the commander *Mohamed Aghenaj* carried a campaign on Souss in (1225 AH/ 1810 AD) and he created Kasbah in Tiznit known as *Aghenaj Kasbah*^(١٢) made *Hassan I-Al. Sultan*^(١٢) two campaigns on the region in (1299AH/1882AD) and (1303AH/1886AD), one of their results was to fortify Tiznit by buildings its walls and renovating its Kasbah and making it as a base to extend his influence on the region^(١٣).

Origin and date of construction:

There is no dispute that the creator of Tiznit walls is Sultan *Al-Hassan I* (1290-1311 AH / 1873-1894 AD). As for the date of construction the researches that dated the walls mentioned that the date of their building comes back to (1299AH/1882AD)^(١٤), but going back to the sources that^(١٤) dealt with the history of *Alawite* state especially the period of Sultan *Al-Hassan I*, we find that they have conflicts in the date of the wall construction. In the coming lines, we'll discuss the opinions contained in the dating of the walls to reach the correct date for its building.

For the opinions that mentioned that the walls are dated back to the year (1299AH /1882AD) they relied on Sultan *Al-Hassan I* visit to Souss and Tiznit which was in that year, and this is indisputable, because all the sources that are related to Sultan *Al-Hassan I* confirmed that his first campaign on Souss was in that date^(١٥). But any of these sources mentioned that the of^(١٥) construction was in the same year in which the Sultan visited the town which makes us rule out that the construction started in that year, otherwise these sources mentioned that the Sultan made his trip at the end of that year, so there wasn't enough time after the Sultan returned to his capital *Marrakesh* again, for the processing of money and equipment for construction to send them to the constructors who were appointed in Tiznit.

However, *Al-Mukhtar Al-Soussi* mentioned that "the construction of the wall began on Thursday 5th *Shawwal* 1300AH (1883AD) and done at the end of *Dhu al-Qi'dah* 1302AH (1885AD)"^(١٦) mentioned another date for the beginning of the construction, he said "for *Al'iikrari*. While^(١٦) Tiznit it was built by Sultan *Al-Hassan ibn Mohamed ibn Abd al-Rahman*, he began the building in 1301 AH (1884AD), and it was built in two years and half, he attended it in 1303

AH (1886AD)" (Alhe mentioned another date, he said "when Sultan *Kanouni-Al*. As for¹⁷⁾ *Hassan* passed by Tiznit in 1304 AH (1887AD) returning from his tour to Souss, he stood on it (Tiznit) and ordered to wall it"¹⁸⁾ of building the wall, . And here we are in front of three date¹⁸⁾ which of them is the correct one? Back again to the sources we find that Sultan *Al-Hassan I*, made his second trip to Souss in (1303AH/1886AD) and visited Tiznit, he criticized the tightness of the wall and told Tiznit people, "*You narrowed the wall to yourselves*"¹⁹⁾. This¹⁹⁾ provision indicates that the construction of walls was really done in (1303AH/1886AD) or before, which means that the date (1304AH /1887AD) that was mentioned by *Al-Kanouni* was incorrect. If we returned to the reasons that prompted the Sultan to carry out his first campaign on Souss and his constructions for walls of Tiznit, it was his attempt to control those areas and subjugate the rebel tribes in them, and confront European ambitions in possession of the coast of Souss. All of this was a motive to accelerate the process of building the wall to prepare the city to be a center for gathering the forces and to play the role assigned to it. As we'll mention. If we considered that the Sultan had finished that tour in *Ramadan* 1299AH (July 1882AD) there wouldn't be any excuse for the delay in the construction process till year (1301AH/ 1884AD) as mentioned by *Al'iikrari*. Especially that "Charles de Foucauld" mentioned that, shortly after the return of the Sultan, designers and architects were sent for the construction of the city to begin and it was surrounded by a wide and square wall²⁰⁾. Accordingly, I support²⁰⁾ the view that the construction work began in (1300AH / 1883AD).

Reasons for building the wall:

There were many reasons that combined and pushed Sultan *Al-Hassan I* to build the wall for the city of Tiznit. The city has been under siege several times by the anti - *Hashem* family forces, and the city was only fortified by a short fence of adobe as it turns usually around the orchards²¹⁾, talked about Tiznit construction *Kanouni-Al*". *'iishbar*, which locally known as²¹⁾ he said, "Reform is still in progress in Tiznit, it was a small village with no walls and it was surrounded by *'iishbar* to fend off the hostility of tribes"²²⁾. It seems that the wall was small²²⁾ and primitive it couldn't protect Tiznit well. Even that *Al-Soussi* described it by saying, "Then, it had a small fence as for orchards"²³⁾. Which pushed the Sultan to build a wall to fortify the²³⁾ city and defend it.

Also, the aim of building the wall of Tiznit was to find a fortified center and a base to control the tribes of the region especially, the ones who pro *Tizirwalt* the center of revolutionaries and their stability. Back to the age of Sultan *Al-Hassan I*, Tiznit was like any other Soussy area submitting only to the primps recruited on the city of Taroudant, and as a result of the visit of Sultan *Al-Hassan I* to Souss in (1299AH/1882AD), the Sultan decided to fortify Tiznit and make it a military and administrative center that overlooks the extended areas between *Walvas Valley* and the borders of *Noul valley* and *Guelmim*²⁴⁾. This formal procedure was decisive to²⁴⁾ the elevation of the country to be a capital after it was a mere big village in the past, and a commander was appointed on it called *Masoud al-Rashidi*. It seems that the central government needed a permanent center in the area to use it in extending their authority over a region known with unrest and disturbances. This procedure was followed by appointing *Mohamed ibn Hassoun* as a commander of the tribe of *Ait Tiznit*²⁵⁾ play The two commanders were able to²⁵⁾ the role dictated by the Sultan where they extended their influence on the neighboring tribes thus, they stopped the greed of the anti-sultan tribes to expand towards strategic areas in the

plain of Tiznit. By playing this role Tiznit became a decision and control center and by that the relationship and connections between the center and its tribal environment increased²⁶⁾

Sultan *Al-Hassan I* needed as well a permanent center in the region to gather his followers from administrators, military personnel and notables to facilitate the task of monitoring the Sultan coasts to fend off colonial powers (Spain – England – France – German – Italy) that were aspiring to control those coasts²⁷⁾. The Sultan made his first move to Tiznit to put an end to²⁷⁾ that greed to show his strength for tribal leaders, and in front of the Sultan's keenness to establish contact with local representatives, he decided to build a wall for the unvaccinated Tiznit, he ordered the commander *Masoud al-Rashidi* to build the wall²⁸⁾ (addition to the defensive . In²⁸⁾ and security role of the wall, it was constructed to deal with the economic damage of the country as a result for foreign trade with some Susan tribes, and thus cut the road to a strong local root that was able to complete the central government economically²⁹⁾. The construction of the wall²⁹⁾ has created an environment and lasting political stability that gave the country a new dynamic that explain some what the demands of the notables and nobles of Tiznit from the Sultan for the reconstruction and development of the town commercially like other royal cities³⁰⁾

The walls also had asocial and cultural functions as they mainly contributed to the consolidation of a sense of belonging to the city and they strengthen the ties among the population belonging to them³¹⁾ . They also play their role in preserving the city's cultural and artistic heritage³¹⁾ Whatever the case, the Sultan was keen to maintain his subordination to Tiznit as a pro requisite for his control over the southern part and extend his control over it.

Financing the construction of the wall:

The construction of the wall took a period more than two years, according to *Al-Soussi*, the construction took two years and two months³²⁾ (alls were mentioned that Tiznit w *Al'iikrari*. But³³⁾ built in two years and a half. But, who was financing the construction all this period? Are³⁴⁾ they the commanders of Tiznit and its notables and tribes or they were funded by the Sultan? Sultan *Al-Hassan I* sent to his commanders in Tiznit all the necessary capabilities and supplies, money and workers to build the wall. The construction expenses were taken from the revenues of *Alssaouira* port³⁵⁾. He also sent the design and the area of the wall and the architects to³⁵⁾ them³⁶⁾ (e designs of the walls and estimating their area were made by . This confirms that th³⁶⁾ Sultan *Al-Hassan I*, according to a vision that corresponded to the roles that would be played by the city as the Sultan wanted, he sent designs to the commanders of the construction and money for construction.

The Sultan has shown great interest in the construction progress. It is noticeable that much of the correspondences between the Sultan and his representatives in the country concerned the technical and organizational aspects of building the wall. But it is unfortunate that who standing on the construction narrowed the area of the drawn wall too, much other than what was planned to keep the money for themselves³⁷⁾. Which prompted the Sultan to blame them when he saw³⁷⁾ the narrow wall during his second tour to Tiznit in (1303AH/1886AD)³⁸⁾ . Perhaps this short³⁸⁾ hand of the area of the walls was what made the wall not to surrounded all the tribes and villages of *Aït Tiznit*. The walls included only four of them which were *Id Ougfa*, *Id Zekri*, *Id Dalha* and *Aït Mohamed*. As for what is left of them outside the walls, were *Tadwarat*, *Atban*, *Du Terka* and *Laouina*³⁹⁾. Were these last villages planned to be within the limit of the walls by the³⁹⁾ Sultan *Al-Hassan I*, who denied on Tiznit people to narrow the walls?

Description of the wall:

The city of Tiznit runs an area of 1.15 km², it's fortified by a wall of length 4.55 km^(ap M⁴⁰) 2). Its current high is 5.5m, it extends in straight lines interspersed with some refractions and wraps which are 1m thick, and some of the lower parts of the wall and its towers were supported by sloping terraces from Tapia and stones varying height known as "*Al-Zalaliq*"⁽⁴¹⁾, which was one of the basis consolidation features in the middle ages^{(ard} , and it's a building tilted out⁽⁴²⁾ to support the wall from below and protect it from corrosion or creation of holes.

The wall was built of plain masses of Tapia, it had no inner passes and above it there was rampart walk that was 0.50m high and 0.50m thick, topped up with rectangular battlement, some of them had a hierarchical top, the height of each one today is about 0.53m and its width is about 0.48m. The wall and the towers also contained gutters from palm trunks to drain rain water (Fig.1).

The wall supports 63 towers, no distribution of distances or regular separations were observed, as the distance between them varied from 42m to 120m. including 50 small towers square shapes, its length of the side is 4m, their height rises as the wall (Fig.1). 13 big towers were distributed on the angles of the wall and were formed similar to the towers of *Al-Qusur Al-Sahrawiyah* (residential fortified settlements in the desert). They have a rectangular base that stands out from the wall by 4.50m, its width is about 5.50m, they're getting thinner when they're up.

The large towers consist of two levels, a lower level has a door that opens toward the town and is used for storage, and an upper level which is used for monitoring and reconnaissance, it can be reached through an internal ladder aligned with the wall (Fig.2). The most important large tower:

Belfkak Tower: Attributed to the leader *Belfkak* who was at the head of the military garrison in *Guelmim* then he became a leader for Tiznit in (1318AH/1900AD)⁽. It's located at the⁽⁴³⁾ Southern angle of the wall of the city. It's 10m in height, today it doesn't have any crenellations (Fig.3).

Terrkeen Tower: It was called by that name because it was located by a coal store (Terrkeen in Tamazight)^{(Gate}, it is 8.10m in height, it's *Ouina-Al*. It is located in the western side by⁽⁴⁴⁾ topped by crenellations numbered by 4 in each side and 4 at the corner, and at its lower and higher levels, it contains narrow slots on the inside and ample on the outside (Arrow slit) as they were used to fire shells, as well as they were used for monitoring and ventilation (Fig.4).

Aglou Tower: It was called by that name attributed to the tribe of *Aglou*, it is located in the northwestern center of the wall, it is 9m high (Fig.5).

Kaied (leader) Mubarak Tower: It is located approximately in the middle of the northern wall, it is 7.50m high. It is distinguished by the fact that its pillars rise in hierarchical form (Fig.6).

Targa or Al-Sakia Tower: It's located to the east of *Targa Gate* at the northern wall, it's 7.50m high and it looks like *Kaied Mubarak* tower (Fig.7).

Id Ougfa Tower: It's known also by *Sedi Bogbbara* attributed to Saint *Bogbbara* whose Shrine is located in the tower, it is located in the northeastern corner of the wall, it's 8.50m high, and its top has no crenellations (Fig.8).

It is good to mention that some towers weren't elevated to the current level when were initially built. Rather, they were elevated in later stages like *Id Ougfa* and *Kaied Mubarak* towers⁽⁴⁵⁾

The wall is in good condition today with the exception of a fragment that collapsed which is about 30m in length to the west of *Targa gate*.

In the wall there are eight gates which are opened, some of them are original and some were added in later periods, and they are:

Al-Khames Gate: (Fig. 9-11) It opens to the north of the wall, it was called that name because it was leading to the Thursday market (*Al-Khames* market), it is a building block that stands out its western side from the wall 4.50m, its eastern rib stands out 5.50m, its height is 6.85m, its pillars rise from the top of a pyramid-shaped body, surrounded by six crenellations in its long rib and two crenellations in its short rib, and with that it looks like *Kaied Mubarak* an *Targa* towers. It has a width of 9.60m, in the middle of it, there is a rectangular entrance with a capacity of 2.40m and its height is 3m. Its jamb was built from stones and it was topped by a semicircular arch that was also built from stones. It leads to a straight passage which is 2.60m wide, covered by a tunnel vault its height is about 4.25m. In the middle of the passage on the right and on the left there are two entrances, they're 1m wide and 1.50m in height and its topped by a semicircular arch, each one of them leads to a rectangular room that was used to store any kind of taxes from merchandise. unfortunately, these entrances are blocked today.

Targa Gate: (Fig. ١٢-1٤) It is located to the north of the wall to the east of *Al-Khames Gate*, and it's also known as "*Al-Sakia Gate*" which is the Arabic meaning of the Tamazight word "*Targa*", and it was known by this name because it was leading to the fields and orchards known as "*Sakiat Targa*". It is reported that in the past it was the main entrance of the Sultan's envoys to the leader of the city⁽⁶⁾. It is a building block supported by a large tower for surveillance and fortification, it stands out from the by wall 5.50m, it's 7.55m in high, topped by four crenellations at the corners and four at its long rib and three at its short rib. The span of the door, including the tower that supports it, reaches 9.60m, and its height is 5.90m, and it is topped by five crenellations. It contains a rectangular entrance with a width of 2.40m, and a height of 3m. Its jamb was built from stones and it's topped by a semicircular arch that was also built from Stones. It leads to a straight passage it's 3.60m wide, covered with a flat roof of branches and sticks. To the right of the interior to the passage there is a rectangular entrance, it's 1m wide and 1.90m high, it's topped with a lintel of branches and it is closed by a wooden shutter, leads to a rectangular room at the lower level of the tower that supports the gate, and the upper level of the tower contains a monitoring and reconnaissance room that can be accessed from the top of the gate surface.

Aglou Gate: (Fig. 15-17) It is located in the western side of the wall, and was named by that name because it opens towards *Aglou* tribe. It is a masonry block, its southern rib stands 6.60m out of the wall, its northern rib stands out by 6.90m, and its height is 6.85m, its top has no crenellations. The width of its façade is 10m, in the middle of it there's a rectangular entrance, it's 2.80m in width and 3.30m in height, its jamb was built from stones and it's topped by a semicircular arch and it was also built from stones and surrounded by a prominent rectangular frieze 0.10m wide. The two spandrels are decorated with two stars eight, inside each of them a rosette with twelve petals.

The entrance leads to a straight pass 3.10m wide, covered with a tunnel vault, and in the middle of the pass on the right and left inside there are two recess, each one of them is 0.50m deep, 2.60m wide, 3.60m high, topped with a semi-circular arch, and each recess is mediated by an entrance 0.80m wide and 1.80m high, shuttered by a wooden shutter and leads to a rectangular

room. Beside the recess which is on the right, there's an entrance 0.80m wide and 2m high, it's topped with segmental arch, shuttered by a shutter of wood.

Al-Madeer Gate: (Fig. 18-20) It is located in the eastern side of the wall, and was named by that name because it opens towards *Al-Madeer* tribe. It is a building block that protrudes from the wall by 6.60m, its height is 6.66m, and its top has no crenellations. The width of its façade is 10.85m and mediated by a rectangular entrance, it's 2.60m in width and 3.10m in height, its jamb was built from stones and it's topped by a semicircular arch that was also built from stones, on either side of the portal entrance there are two merging columns each of them is crowned with an ionic capital. The two spandrels are decorated with two circular bosses, in the middle of each one there's a flower of eight petals. The entrance was closed by two shutters of wood, the left shutter is located to the left and it shows residues covered in leather. The entrance leads to a straight pass, its width is 2.80m, the pass contains four recesses, two on the right and two on the left, the breadth of each is 2.20m, 0.40m deep, 2.70m high, and topped with a semi-circular arch. The pass is covered by a tunnel vault, that has a square opening in the middle, its side length is 2.60m.

Ouli Gate: (Fig. 21-23) It is located in the southern sector of the western wall, this gate was not present from the beginning, therefor it opened to one of the small towers, and it was opened during the French protectorate by *Al-Sheikh Bo Obeid*, to be a way for *Id Dalha's* livestock towards the pastures, for this it was called "Ouli Gate" attributed to the flock of sheep⁴⁷⁾. Also known as "Bo Obeid Gate" attributed to *Al-Sheikh Bo Obeid* who opened it. The gate bears the date of (1311 A.H) perhaps it's the date of its building. The gate starts with an entrance opened in the side of the tower, it is 2m wide and 2.20m high, topped with a semi-circular arch, the arch and spandrels are surrounded by a rectangular frieze, with a central date of (1311) on the top of the arch. The entrance leads to a rectangular space with no roof, it's 3.40m long and 3m wide, and it contains another entrance leads to inside the city, that entrance is rectangular, it's 2.20m wide, 2.90m high and covered with a lintel of tree branches.

Aït Jerrar Gate: (Fig. 24 a) It is located in the southern side of the western wall, it consists of two straight wide entrances, topped with semi-circular arches, leading to two straightens for *Abd Al-Rahman* street inside the city. It is a new gate that was built in the age of the French protectorate to facilitate entry and exit of the cars after the original gate was destroyed after its expansion⁴⁸⁾. As for the original gate according to some old pictures, it was a prominent tower from the wall, its pillars rise from the top of a pyramid-shaped body, and confined among them five crenellations in the long side and three crenellations in the short side, and it is similar in appearance to *Al-Khames Gate*, and *Mubarak* and *Targa* towers. In the center of the tower there is a rectangular entrance topped with a semi-circular arch, and leads to a straight corridor which is uncovered in the middle.

Jadid Gate: (Fig. 24 b) It is located in the western south side of the wall, and it is a new gate, as the French protectorate extended it to facilitate the movement of cars in the direction on *Al-Mechoir* square, which is considered the administration and economic center of the city of Tiznit⁴⁹⁾. Gate in its composition after its expansion *Aït Jerrar*. And it is similar to⁴⁹⁾

Al-Ouina Gate: (Fig. 24 c) It is located in the western south side of the wall to the north of *Jadid Gate*, and it is a new gate because it was done in the period of the French occupation, and it was called by that name because it was facing a distance of 5 km from a village called *Al-Ouina*⁵⁰⁾. It consists of two wide entrances to facilitate the entry and exit of cars from and to⁵⁰⁾

the city, and next to it there are two small openings to the entry and exit of the pedestrian, and it is similar to *Jadid* and *Ait Jerrar* gates.

The building materials:

Tapia⁽¹⁾ was used as a main building material in the wall and their towers and gates, some other materials were used with it like stones that were used in the gates and in the ramps that support the bottom of the wall. Wood and tree branches were used in the doors shutters and in some lintels and roofs of entrances and towers. Palm wood has also been used to make gutters that drain water from the top of the wall and towers.

How to build the wall?

The construction of the wall begins with the foundation drilling of 0.50m, it is built with irregular stones, held together with a large amount of mortar. Then it is followed by building a wall that is less thick than the stone to a height ranging from 0.20m to 0.50m to protect the bottom area of the wall from the effect of water that breaks down the Tapia over time. After completing foundations and the bottom wall a process of fetching a large amount of raw materials begins from which the mixture is installed and mixed together by adding water and it is left to ferment for several days until construction begins, where the necessary quantity is prepared for work within one day, taking the necessary precautions to cover this mixture and the newly completed wall with a wooden lid prepared for this purpose for the event of rain during the daily work⁽²⁾.

After preparing Tapia, the mixture is transported by a pail and poured in the "Box" or "Tabout" (Fig. 26) which consists of wooden boards tightening on the basis of the wall in a parallel position and they are joined together by wooden blanks fixed with nails, and spaced out between those boards according to the required thickness of the wall. These boards are connected together from the top by arms of wood known as "Al-Wakafat", it is tied with ropes, the other two sides of this box are blocked with two small boards of wood (Fig. 27). After putting the mixture of Tapia inside the box, it's squeezed by a wooden tool known as "Al-Merkaz" until mixture parts overlap and become one body (Fig. 28). Thus, the box is re-installed in the previous way until the Tapia blocks are organized raw after raw and the whole wall looks fused as it was one block. The manufacturer is called "Al-Tawab" or "Al-Rakaz"^(ig. 29). There F.⁽³⁾ is another way to tie the two boards of wood that make up the box, the pieces of wood are anchored to the center of the wall vertically, and planks are fixed by ropes, the average distance among the vertical wooden pieces is 0.85m, so as not to hinder the construction process⁽⁴⁾. At⁽⁴⁾ the height of the wall, construction materials are raised to the top by rope and reel (Fig. 30). For the construction of the wall to be elaborate and well-balanced, "Al-Tawab" must have a scale, and often it is the thread balance or piece of wood to adjust the aesthetic of the wall from the inside and outside. Also, building with the Tapia needs red bricks or some of the pieces of wood to cover the part that was built when moving from a row to another, this is because red bricks or wood create some empty space under the box, then the lower wooden arms of the box are easy to pull out⁽⁵⁾. It is possible to be reach a different number of rows per day according⁽⁵⁾ to the construction levels, especially if skilled labor is available⁽⁶⁾ and the suitable climatic⁽⁶⁾ conditions that allow for quick drying of the building and this time varies according to the

seasons. In the summer, it ranges from eight to ten rows on the ground level and six to seven rows in the second level, as for the fall season, it will be four to six rows on the ground levels, and four or five rows in the second level⁽⁷⁾.

After work was stopped in the evening, the top part of the wall that was finished recently is covered with a thin layer of the same soil used in construction to avoid the impact of sudden climatic factors, this layer is removed when returning to complete the construction the next day. After the construction of the wall is completed, it is allowed to dry for a period ranging from three to six days according to the seasons⁽⁸⁾. To increase the durability of the wall it's added⁽⁸⁾ to the mixture every now and then pieces of wood their length doesn't exceed the width of the wall and are thin, and other longitudinal pieces straight or slightly twisted are placed next to each other on the longitudinal span of the wall⁽⁹⁾.

The analytical study:

Layout and shape of the wall: The wall of Tiznit was extended in straight lines and was interspersed with some warps, this is due to the topography of the city that was built on flat land of *Azgar* plain. These types of walls characterized by its ease and speed of construction relative to other walls. It could be provided using the raw materials, as the straight line is shorter than the winding line, in addition it gives more regular internal spaces. As for its draw backs, it has less durability than the winding wall so they were strengthened with the highest number of towers at close distances, which increased their durability and defensive ability. And this is what we notice clearly in the western and western south ribs of Tiznit wall as they're the most straight forward sections of the wall, therefore it must be strengthened with the biggest number of towers that's why they contained 28 towers.

Also, the winding, refractions and those angles in the wall increase their durability and power, plus they create corners in the wall to make defenders abler to defend it, in case the attackers approached the wall from the spots of these corners (angles) where the number of defenders increase on the top of the wall in areas of angles. This phenomenon in Islamic western countries dates back to Umayyad period, where we note the tendency to the flexes in the walls of some fortifications that is dated back to the Umayyad in Andalusia like *Banios de Anthena* fort, and in the remain of the wall of *Al-Okab* fort (*las navas de Toloza*). This phenomenon has evolved in Morocco in the age of Almoravids where we see it in the wall of *Amergo* castle and *Tasghemot* castle. These corners allow defenders to surround the attackers through the path above the wall when these attackers advance inside one of the corners then the opportunity becomes favorable to kill them⁽¹⁰⁾.

It seems that the fortification of Tiznit had direct impact on its area which is limited, even that the perimeter of its wall reached about 4.55km, perhaps the limited space was related to the quickly finished construction and the ability to build these fortifications and their huge construction costs, and provide the soldiers with the equipment necessary to protect it, this is in addition to the fortification system that it is better to have smaller spaces to be easy to defend⁽¹¹⁾. That as well as the builders of the wall narrowed its area to save money for their benefit as⁽¹¹⁾ already mentioned. The limited area of the city had an effect on distribution of its architectural units as it didn't include some facilities that needed a large space like *Al-Khames* market, which was held outside the city walls from the northern side, within the city through *Al-Khames* gate,

which took its name from this market. Besides the existence of this market outside the walls preserving the security of the city, its cleanliness and calmness.

It is known structurally that the height of the wall is related to its thickness, the wall of Tiznit had reached a height of 5.50m in line with its thickness of 1m, we notice that this small thickness doesn't allow to create paths inside the wall for shooting so the wall has to become solid inside. Also, this small thickness had an impact on the width of the rampart walk at the top of the wall that reached 0.50m by which the cannons couldn't be placed on the top of the wall, but it can be replaced by placing the cannons on top of the towers, especially most towers are solid so they are characterized by their durability and their ability to withstand the weight of cannons and their reaction during launching shells. In addition, the surfaces of these towers are exposed and they are not covered in order for the stifling smoke and gases from cannons and guns not to affect soldiers who use these guns.

Type of towers: The types of towers used in the wall of Tiznit varied, in terms of architectural composition, there are two types of towers:

Solid towers: they have a construction job, they work to support the wall, it contains a rampart walk on it for the guards and to fire the shells from it at the enemy as the rest of the surface of the wall.

Towers with rooms: these are large towers that contain two levels of rooms as the lower rooms were used to store goods and the upper rooms were used for monitoring and reconnaissance as mentioned above, and these rooms are covered with flat roofs from tree trunks and branches.

It is worth mentioning that solid towers that aren't topped with shooting rooms were most commonly used in the military installations in Morocco and Andalusia like in the walls of Rabat, Marrakesh, Fes and Seville in Almoravids age, and in the kasbahs of: Boujloud, Oudayas, Merida and others. Perhaps this is due to the primary function which these towers were created for, which is the structural function represented in strengthening the walls and increasing their durability, they were also used for defense. The large number of these towers are also due to the ease and speed of building them with less cost, they were smaller than other types of towers and their height was equal to the height of the wall. These towers also correspond to the use of cannons as they are stoned, which enable them to withstand the weight of the cannons and their reactions. They also have exposed surfaces, so smoke from cannons doesn't cause any damage for the defenders as mentioned above.

Heights of towers: The height of the towers varied in the city wall, the elevations were directly related to the function of the tower. The small towers are as high as the wall (5.50m), and these heights are in line with the main function of these towers which is the reinforcement of the wall. The large towers were higher where their heights range from 7.50m to 10m, and this is consistent with its function of surveillance and reconnaissance.

Shapes of towers: All the towers of the wall have taken square or rectangular projections, the architect might have used these types of towers for their durability, resulting from the interconnectedness of their corners or as a kind of architectural heritage, and maybe for their ease and speed of construction. And maybe because they have more space inside and they are more regular than the circular or polygonal towers, then they absorb a greater amount of material that is stored in their lower rooms and absorb a greater number of defensive and observer soldiers in their upper rooms, hence more defensive ability.

The gates: Gates are the main communication element connecting the facility to its outer circumference and when the security necessity fortified the cities with walls, gates in these walls had to be opened to enter and exit through them. The gates in the walls of the city perform multiple functions in peace and war. In peace they represent the graphs of connection between the city and the outside, and in war when the gates were the weakest point in the wall and the most vulnerable to break down, they had to be provided with architectural tricks in planning, design and construction materials to repel any attack they may be exposed to.

To hamper the attackers several design solutions were created, initially, the entrances were direct consisting of one opening that is closed by two shutters through which the gates are opened and closed. Then the development occurred in the entrances in the age of *Abd Al Rahman Al Naser*, and to be precise in the gates of Cordova in (301AH/913-914AD) ^(by⁶²) adding an interior opening facing the external opening, then the entrance changed to be having two openings on which shutters of wood or iron are installed. Then the multiplication of the number of doors, fortifications or obstacles facing the attackers, and doubling the number of guards. And with the development of architecture and elements of architecture, entries have evolved and a new quality has emerged known as "Bent entrances". The Bent entrance is the entrance where the interior deviates right or left once or several times before he reaches the inside of the facility, this type of entrances was used in defensive architecture for the purpose of reducing the attackers rush in the event that they can penetrate the outer entrance⁽⁶³⁾. As well⁽³⁾ the creator cared about choosing the appropriate position for the gates in the walls and directing them towards the right direction to do their job properly, the gates were distributed in all directions of the wall as they connected between all the positions of the city with their different formations and its external environment.

Gates planning: As the gates were one of the weakest points in the walls the architect worked to fortify them in a variety of ways until the gates became one of the most difficult points through which the enemy could storm climbing the walls, or prospecting them to become easier comparing the fortifications and obstacles encountered by the enemy to defend the gates⁽⁶⁴⁾. All Tiznit gates had direct entrances except *Ouli* gate. The bent entrances weren't used perhaps that was due to the use of fire arms at that time, so some of the features of the military architecture changed to adapt to this new development in arming.

As the gates had direct entrances, they had to be further fortified and to increase their defensive capability by using a set of architectural tricks in their design and construction materials to increase their durability and defensive capability, where the stones with tapia were used in building the gates, as well as being built in the form of large architectural blocks to stand out from the wall and higher than it. Also we note some of the gates their passes contain recesses from which the defending soldiers are placed then they can surprise the enemy, attacking him in case of storming the gates in times of war. In case of peace, these recesses work on absorbing the soldiers assigned to the guard without impeding the traffic of the gate. These recesses also work on increasing the durability of the gates structurally. as in *Aglou* an *Al-Madeer* gates (Fig. 17,18).

Also we note that in some gates their passes contain unforgettable parts that allowed the defending soldiers positioned at the top of the gate to strike the attackers in case they were able to penetrate the outer door and cross the pass, like in *Al-Madeer* gate. And as an increase in the means of fortifications, we find that the wooden doors which were closed on the gates were

covered with leather fixed with metal nails, that to increase their durability, tenacity and ability to resist and absorb the ballistics. also, if this leather is applied to vinegar, it becomes fire-resistant, so the door is protected from the risk of burning⁽⁵⁾. And this phenomenon was not⁽⁶⁾ limited to the cities of Morocco it is also found in Andalusia like in Almeria and Ubeda gates as they were covered with thick leather and fixed with nails⁽⁶⁾ And to protect the entrances of⁽⁶⁾ the gates and to defend them some were provided with a tower on the side of the entrance just like in *Targa* gate (Fig. 13).

Entrances measurements: The measurements of the entrances were varied from gate to gate as shown in (Table 1). In the light of what came in the table, it is clear that the measurements of the entrances were close, except *Ouli* gate, because this door has been opened later to one of the small towers that supported the wall.

The stairs: Stairs are important communication and movement elements that tie different parts of the wall and the towers. Through which defending soldiers are provided with what they need from weapons and materiel on the wall and in the towers. Stairs were used in the wall of Tiznit to reach the top of the wall as well as the upper rooms in large towers. Also we note that the stairs in the wall of Tiznit were carried out with a certain inclination and width of one meter which helped in creating ease of using these stairs on the ascending and descending of soldiers during times of peace and war (fig. 2).

Conclusion:

The study clearly showed the location of Tiznit and its position in *Azgar* plain, and the topographic effect of this position on the layout and shape of the wall. The study also determined the date of building the wall, and resolve the difference contained in those sources about that. The reasons behind the construction of the wall have also been clarified like fortifying the city and turning it into a center and a base to establish control of the Sultan over those areas and suppressing any revolutions, as well as putting an end to the colonial power greed, that was seeking to control trade and coasts of Souss region.

The study also clearly showed the source of financing the construction of the wall which was the revenue from the port of *Alssaouira*. Designing and estimating the area of the wall was developed by Sultan *Al-Hassan I*, according to a vision compatible with the city's job that we have noted in the gates measurements and its entrances which were almost equal. The study also corrected many measurements of the lengths of the wall and its height and the measurements of the towers and the gates contained in previous studies. The study showed that *Tapia* was the main building material in the wall as well as using some other materials like stones and wood. The study also clearly showed how the wall was built and planned which was straight up with some fractures and the advantages of that planning and the reason for its development.

The study also showed the use of two types of towers in the wall: small towers were designed to support, and large towers with storage, monitoring and reconnaissance rooms. The large towers also took the form of *Al-Qusur Al-Sahrawiyah* towers. The study also showed the planning of the gates and their building materials, the architectural and military tricks that were used to achieve the highest durability and capability for defense and fortification. The study also showed the change of shapes, such as arrow slits to match fire arms to become narrow on the inside and widen on the outside. Finally, this wall needs more attention and restoration with

rebuilding of the wrecked part of it beside *Targa* gate, especially that it was the last wall that was built in Morocco.

Tables, Maps and Figures:

Table (1): The measurements of the entrances in Tiznit wall.

The gate	Entrance width	Entrance height	Proportion of width to height
Al-Khames gate	2.40 m	3.00 m	1 : 1.25 m
Targa gate	2.40 m	3.00 m	1 : 1.25 m
Aglou gate	2.80 m	3.30 m	1 : 1.18 m
Al-Madeer gate	2.60 m	3.10 m	1 : 1.19 m
Ouli gate	2.00 m	2.20 m	1 : 1.1 m

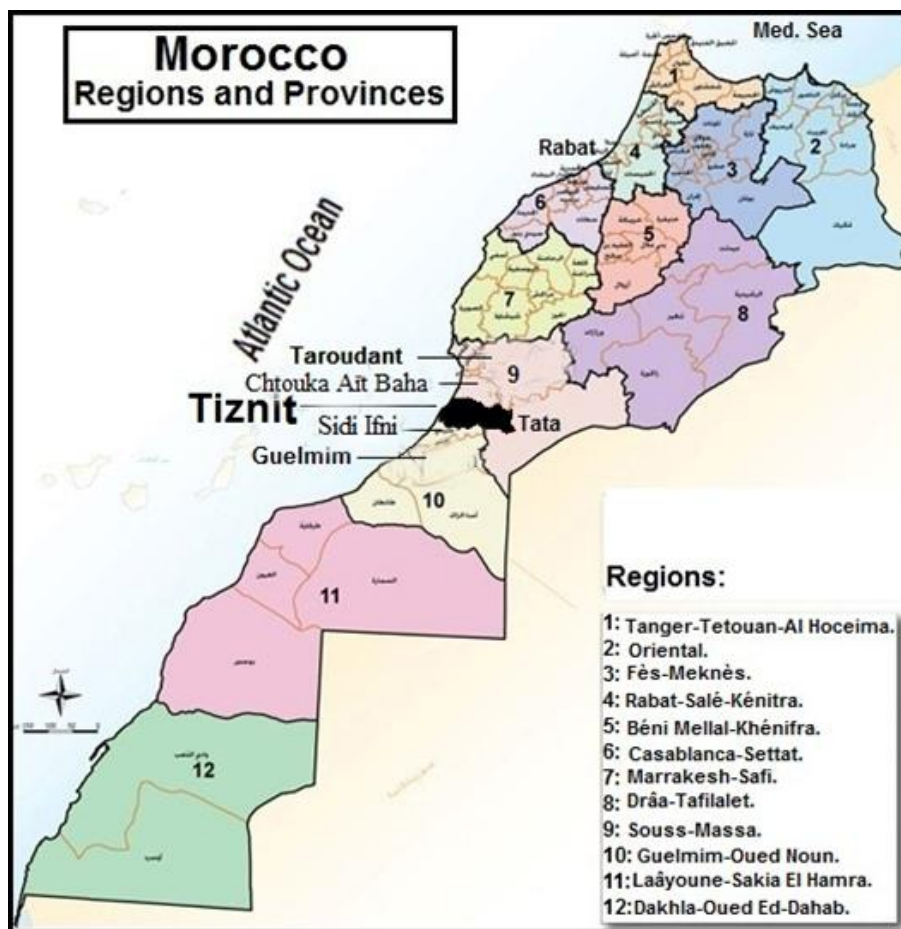

Map (1): Regions and Provinces of Morocco and location of Tiznit, after, <https://saharatodos.map=4142>

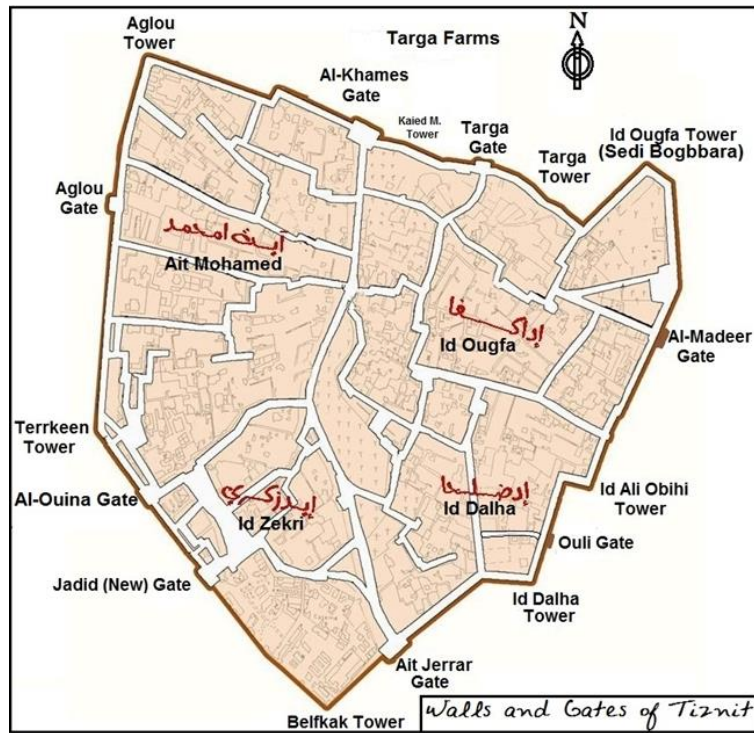

Map (2): Walls and Gates of Tiznit, after, Tiznit Collective memory, p. 68.



Fig. (1): Model of small towers. (photo'd by researcher).



Fig. (2): Model of stairs and doors of towers (photo by the researcher).



Fig. (٣): Belfkak Tower. (photo'd by researcher).



Fig. (٤): Terrkeen Tower. (photo'd by researcher).



Fig. (٥): Aglou Tower. (photo'd by researcher).



Fig. (٨): Kaied M. Tower. (photo'd by researcher).



Fig. (٧): Targa Tower. (photo'd by researcher).



Fig. (٨): Id Ougfa Tower. (photo'd by researcher).



Fig. (9): Al-Khames Gate. (photo'd by researcher).

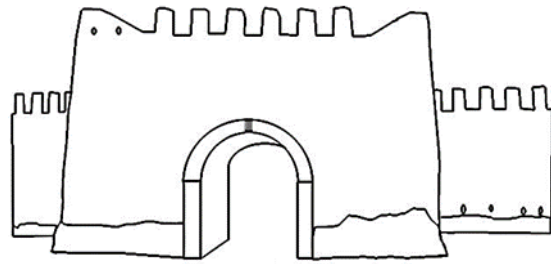

Fig. (10): Al-khames Gate. (Designed by researcher).

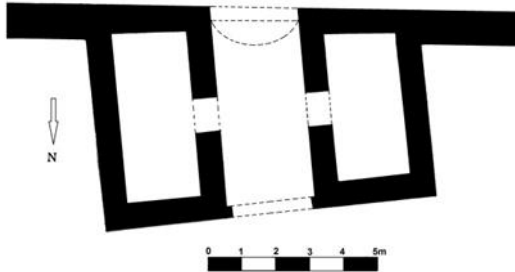

Fig. (11): Plan of Al-khames Gate.

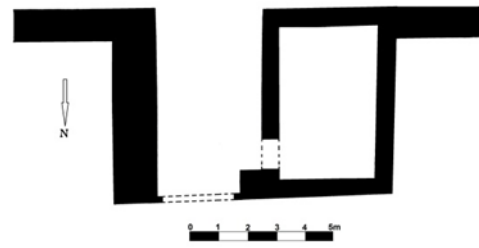

Fig. (12): Plan of Targa Gate.

(Designed by researcher).



Fig. (13): Targa Gate. (photo'd by researcher).

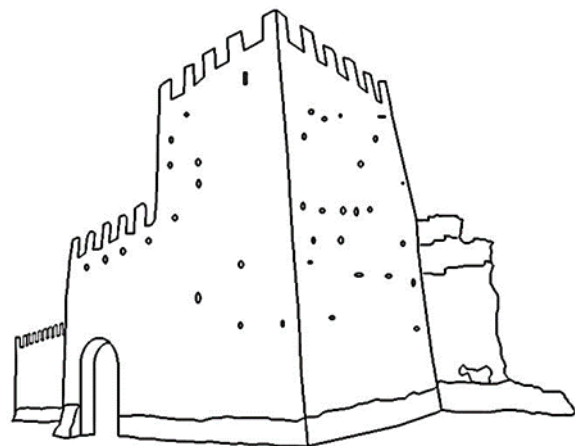

Fig. (14): Targa Gate. (Designed by researcher).



Fig. (15): Aglou Gate. (photo'd by researcher).

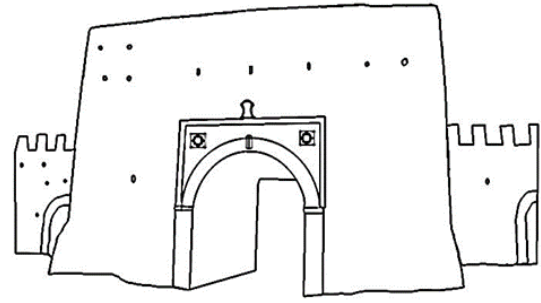

Fig. (16): Aglou Gate. (Designed by researcher).

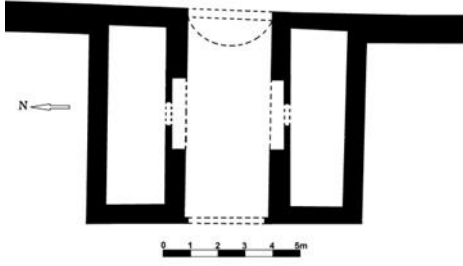

Fig. (17): Plan of Aglou Gate.

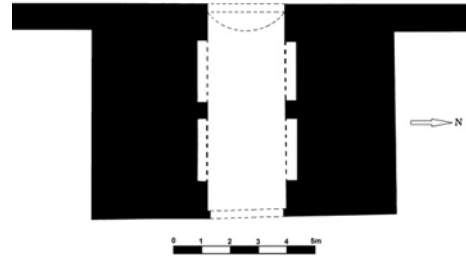

Fig. (18): Plan of Al-Madeer Gate.

(Designed by researcher).



Fig. (19): Al-Madeer Gate. (photo'd by researcher).

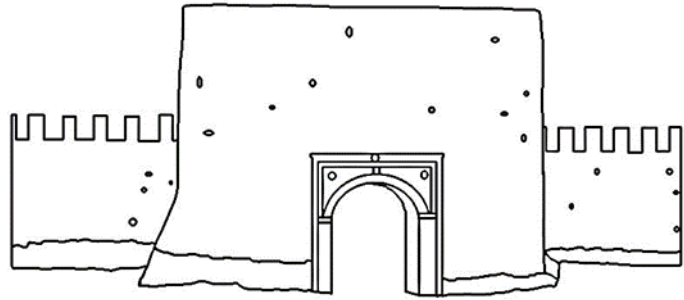

Fig. (20): Al-Madeer Gate. (Designed by researcher).



Fig. (21): Ouli Gate. (photo'd by researcher).

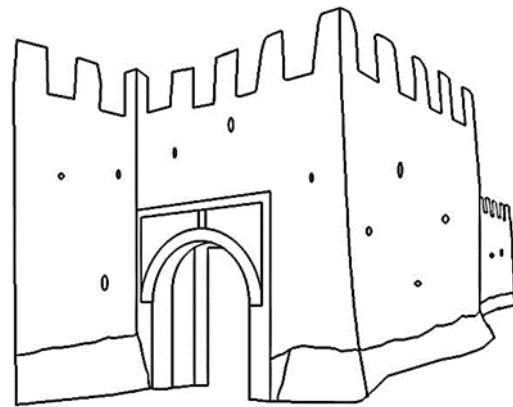

Fig. (22): Ouli Gate. (Designed by researcher).

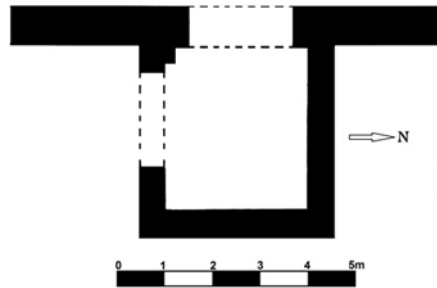

Fig. (٢٣): Plan of Ouli Gate. (Designed by researcher).



(a) Ait Jerrar Gate



(b) Jadid (New) Gate



(c) El-Ouina Gate

Fig. (24): Ait Jerrar, Jadid and El-Ouina Gates. (photo'd by researcher).



Fig. (٢5): Ait Jerrar "Old gate", Bomezko, Amrer: Alm'aālem altarekheia, p. 59.

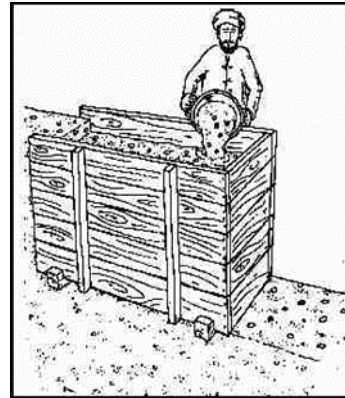

Fig. (26): poured Tapia in a Construction box, M. Teresa y otras: La Alcazaba, p.9.

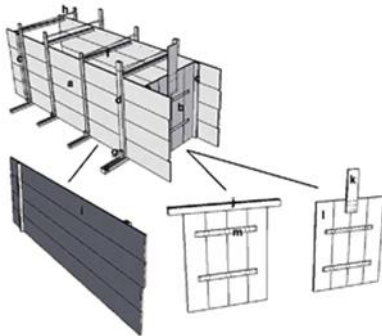

Fig. (27): The box of Tapia, M. Sánchez: El refugio en altura andalusí, fig.6, p.6.

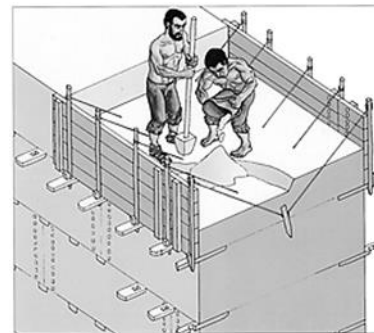

Fig. (٢٨): Construction of walls by Tapia, <http://www.turismobadajoz.es/alcazaba>

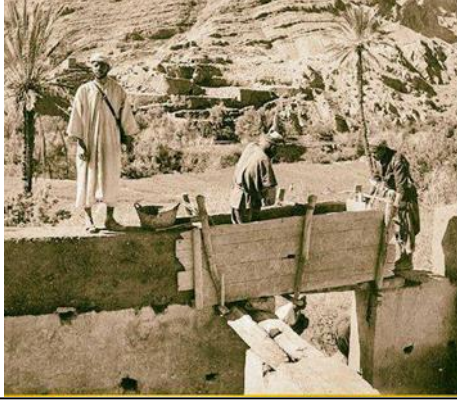

Fig. (29): Construction of walls by Tapia, https://www.facebook.com/dakirati_znit/

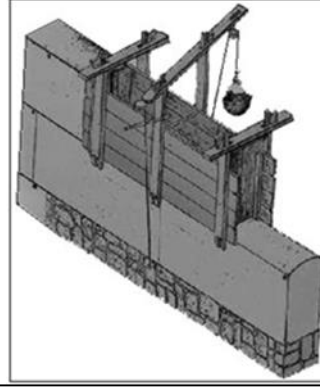

Fig. (٣٠): Lift Tapia over the wall with a rope and a reel, <https://millarensurcitano.wikispaces.com>

References:

- 'Abū Reḥāb (Mohamed), 'Aswār madīnat Tārūdant (Walls of Taroudant City-Morocco), *Journal of History and the Future*, Minia University, (2011), pp. 79-151.
- Aglan (Amer), 'Alqeṣāb 'albāqīa fī 'al'andalus wa 'almaghreb 'al'aqṣa (*The remaining Kasbahs in Andalusia and morocco*), Ph.D., Faculty of Archaeology, Sohag University, Egypt, (2017).
- Aglan (Amer), 'Al'amāl 'almemārīa 'alḥarbīa le-Khīrān 'Al'amerī be-madīnat Almarīa: 'Al'aswār nmozagn (Military Architectural Works of Khairan Al-Amri in Almeria - Walls as a Model), *Journal of the College of Arts - Sohag University*, vol. 51, Part 1, April (2019), pp. 287-293.
- Al-Faṣṭālī, *Manāḥil 'Al-ṣafa fī m'aāthir muālina alshurafa*, publications of the Association of Moroccan Historians, Rabat, (2005).
- Al-Hassanī, *Diwan qabael Souss fī 'aḥd 'alsultān Aḥmad 'Al-Manṣūr 'Al-Zahabī (Diwan of Souss Tribes during the reign of Sultan Ahmed Al-Mansour Al-Zahabi)*, College of Arts and Humanities, Rabat, (1989).
- Al'ikrarī, *Rawdat 'al'afnān*, College of Arts and Humanities, Ibn Zahr University, Agadir, (1998).
- Al-Kanouni, *Asfī-Qademan wa ḥadethan (Asfī-Old and Modern)*, n. d., n. pub.
- Al-Muṣḥrefī, 'alḥolal 'albahīat fī mulūk aldawlat al'alawiat, Publications of the Ministry of Endowments and Islamic Affairs, Morocco, (2005).
- Al-Saktanī, *Agwebat Al-Saktanī*, manuscript No. 2r 217/a.r., King Saud University.
- Al-Soussī (Al-Mukhtar), *Elig, Qademan wa ḥadethan (Elig, old and modern)*, Royal Press, Rabat, (1966).
- Al-Soussī (Al-Mukhtar), *khīlal jazwlat*, Mahdia Press, Tetouan, Morocco, vol.2, n.d.
- Amerīr (Abd al-Salam), Mraḥel tatūr Tiznit men qarīa 'ela madīna (The stages of the development of Tiznit from a tribe to a city), *Tiznit Forum for the Coexistence of Cultures*, Asmoun Association for Social, Cultural and Heritage Preservation, Afolki Press, Tiznit, (2009), PP. 19-22.
- Azuar (Rafael), Las técnicas constructivas y la fortificación almohade en al-Andalus, *Arqueología de la Arquitectura*, número 4, (2005), pp. 149-160.

- Bocard P., *Les guides blues Maroc*, 7eme edition, paris, (1950).
- Bin Nomān (Ismāil), 'Albenā'a be-'alturāb fī belād 'almaghreb 'allislāmī: Teqneat altāpia namozagn (Building with mud in the Islamic western - Tapia technique as a model), *Historical Kan Periodical*, third year, Issue 10, December (2010), pp. 19-26.
- Boumzko (Ahmed), Gwāneb men tārekḥ Tiznit (Aspects from the History of Tiznit), *Tiznit Symposium and its Badia*, Publications of the Faculty of Arts, Agadir, (1996), PP. 23-39.
- Boumzko (Ahmed), Tārekḥ 'almaidīna (History of the City), Tiznit: Collective Memory, *Tiznit Municipality*, Morocco, (2009), pp. 28-33.
- Boumzko (Ahmed), Amerīr (Abd 'al-Salam), Alm'aālem 'altārīkhīa dākḥel 'almaidīna 'al'atīqa (historical monuments in the ancient city), Tiznit: Collective Memory, *Tiznit Municipality*, Morocco, (2009), pp. 55-60.
- Burton (Peter), Islamic Castles in Iberia, *The Castle Studies Group Journal*, No 22, (2008-9), pp. 228-244.
- Crespo (Gil), El debate de las influencias orientales en la arquitectura militar medieval española: casos en la fortificación bajomedieval soriana, *Actas del Octavo Congreso Nacional de Historia de la Construcción*, Madrid, 9-12 octubre (2013), PP. 395-407.
- Cuchí (Albert), La técnica tradicional del tapial, *Actas del I Congreso Nacional de Historia de la Construcción*, Escuela Técnica Superior de Arquitectura de Madrid, (1996), pp. 159-165.
- Daza (Pedro), Rodríguez (Sáez), Ángel (J.), Tapial o fábricas encofradas en recintos urbanos andalusíes, *Actas del II Congreso Internacional "La Ciudad en Al-Andalus y el Magreb"*, Granada, (2002), pp. 561-625.
- Elmi (Ahmed), 'Haraket 'alsultān Al-Hassan I 'ila Souss (Moving Sultan Hassan I to Souss), *Tiznit Symposium and its Badia*, Publications of the Faculty of Arts, Agadir, (1996), PP. 47-60.
- Foucauld (Charles de), *Reconnaissance au Maroc*, Challamel ET C éditeurs, paris, (1888).
- García (Amparo), Fábricas islámicas del mirador almohade de la Muralla de Marchena (Sevilla). Tramos de la Alcazaba y el parquet, *Laboratorio de Arte: Revista del Departamento de Historia del Arte*, N°. 21, (2008-2009), pp. 13-35.
- García (Amparo), Ángel (Miguel), El tapial en el área sevillana. Avance cronotipológico estructural, *Arqueología de la Arquitectura*, número 5, (2008), pp.135-158.
- Harakāt (Ibrāhīm), 'Almaghreb 'abr 'altārekḥ (Morocco through history), Dar Rashad Al-Haditha, Casablanca, (1993).
- Ibn Khaldoun, 'Almoqadema (Introduction), the Egyptian General Book Authority, (2006).
- Ibn Mankali, 'alḥeīal fī 'alḥurūb (The tricks in wars), House of Books and National Documents, Center for the Investigation of Heritage, Cairo, (2000).
- Ibn Zaidān (Al-Alawi), 'almanz'e 'allatīf fī mafakhīr 'almawlaa 'iismāeīl ibn alsharīf, Ideal Press, Casablanca, (1993).
- Ibn Zaydān (Al-Alawi), 'iithaf 'alām alnās bijamāl 'akḥbār ḥādirat meknās, Library of Religious Culture, Cairo, (2008).
- Ignacio (José), Participación de cautivos cristianos en la construcción de la muralla nazari del Albayzín (Granada): sus graffiti, *AyTM*, N° 11.1, (2004), pp. 125-158.
- Karbkhal (Marmol), *Africa*, translated by: Mohamed Hajji and others, Moroccan Association for Authorship, Translation and Publishing, Rabat, (1989).

- Laḥlou (A.), Al-Idrīsī (M.), Almoḥāfaza 'ala aswār almodon al'atīqa (Preserving the ancient city walls), *the National Seminar on Ancient City Walls in Tiznit*, Directorate of Cultural Heritage, Morocco, (1989), PP. 71-107.
- Lamrāni (Mohamed), Alm'emār 'almabnī be-'alturāb fī manteqat Tafīlālt (Mud Architecture in the Tafilalet Region), *Conference of mud Architecture in the Mediterranean*, Publications of the Faculty of Arts and Humanities in Rabat, Casablanca, (1999), PP. 99-116.
- Lapid (Ammār), Abraz 'almazaher 'al'omrānīa fī Alandalus fī 'aṣr 'al^{kh}elafa (Urban prominent manifestations in Andalusia in the era of the Caliphate), *Medad Al-Adab Magazine*, Issue 8, (2014), PP. 445-488.
- Le Chatelier (Alfred), *Tribus du Sud-Ouest marocain: bassins côtiers entre Sous et Drâa*, Ernest leroux éditeurs, Paris, (1891).
- Maldonado (Basilio), *Al'emāra fī Al'andalus "Emāret almodon wa al'hoṣūn (Architecture in Andalusia, "Architecture of Cities and Fortresses")*, translation: Ali Ibrahim Menoufy, Supreme Council of Culture, Cairo, (2005).
- Monsieur (G.), Les remparts des médinas élément de défense et d'organisation, *National Symposium on Ancient Cities Walls in Tiznit*, Directorate of Cultural Heritage, Morocco, (1989), pp. 161-163.
- Nāfi (Al-Hussein), 'iishkaleat mawqe'e madīnat Tiznit wa 'aāleat twas'oha (The problematic location of the city of Tiznit and its expansion mechanisms), *Tiznit symposium and its Badia*, Publications of the Faculty of Arts, Agadir, (1996), PP. 161-163.
- Othmān (M. Abdul Sattar), *Almadīna 'al'islāmīa (The Islamic City)*, dar alafaq alarabia, Cairo, (1999).
- Sālem (Abdulaziz), Adwā'a 'ala moshkelat t'aarekh benā'a aswār 'Ishbillīa (Spotlight on the problem of the construction of Seville walls in the Islamic era), *Journal of the Egyptian Institute for Islamic Studies in Madrid*, vol. 18, (1974-1975), PP. 131-153.
- Sālem (Abdulaziz) and others, Al'amā'ar Alḥarbīa b'almaḡreb 'al'aqṣa "Alqesab Nmozagn" (Military Architecture in far Morocco "the kasabh model"), *Journal of Architecture, Arts and Humanistic Sciences (MJAF)*, Vol. 5, Issue 23, (2020), pp. 664-686.
- Sánchez (Miquel), El refugio en altura andalusí de Vilella (Almiserat, Valencia), un ejemplo de arquitectura defensiva rural en el ámbito centro-meridional valenciano (ca. 1150-1250), *Arqueología de la Arquitectura*, número 10, enero-diciembre (2013), pp.1-20.

¹ - Nāfi, 'iishkalīat mawqe'e madīnat Tiznit, p. 161.

² - Boumzko, *Tārīkh almadīna*, p.28.

³ - Boumzko, *Gwāneb men tārīkh Tiznit*, p. 25.

⁴ - Amerīr, *Mrāhel tatūr Tiznit*, p. 20.

⁵ - Karbkhal, *Africa*, vol.2, p.31; Abu Rehab, *Aswār madīnat Tāroudant*, p.93.

⁶ - Al-Soussi, *khelāl jazwlat*, vol.2, p.168.

⁷ - Harakat, *Almaghreb 'abr 'altārīkh*, vol.2, p.178.

⁸ - Al-Fashtali, *Manahil Al-Safā*, p.254; Abu Rehab, *Aswār madīnat Tāroudant*, p.95.

⁹ - *Alserj*: is a statistic unit consists of 15 *Kanwon* (Stove), and considering that "*Kanwon*" or "Family" consists of 5 persons as an average number. Thus, the persons number of *Alserja* (one serj) is 75 members. Al-Soussi, *khelāl jazwlat*, vol.2, p.189.

¹ - Al-Saktani, *Aḡwebat Al^lSaktānī*, p.97 and beyond.

¹ - Al-Hassani, *Diwān qabdel Souss*, p.28.

¹ - Boumzko, *Tārīkh almadīna*, p.29.

¹ - Ibn Zaydan, *Al-'iithāf*, vol.2, p.251; Al'iikrari, *Rawdat 'al'afnān*, p. 69.

- ¹ - Bicard, *Les guides blues⁴ Maroc*, pp. 218-219; Boumzko, Amerir, *Alm'aālem altarekheia*, p. 55.
- ¹ - Ibn Zaydan, *Al-'iithāf*, vōl.2, p.247; Al-Mushrafī, *'alholal 'albahiāt*, vol.2, p. 160.
- ¹ - Al-Soussi, *khelāl jazwlat*, vol.2, p.191.
- ¹ - Al'iikrari, *Rawdat al'afnān*, p. 69.
- ¹ - Al-Kanouni, *Asfi- Qadeḥan wa 'hadethan*, p. 57.
- ¹ - Al'iikrari, *Rawdat al'afnān*, p. 69.
- ² - Foucauld, *Reconnaissance au Maroc*, p. 344.
- ² - Al-Soussi, *Elig, Qademān wa 'hadethan*, p. 241; Le Chatelier, *Tribus du Sud-Ouest marocain*, p. 118; Elmi: *'Haraket alsultan Al-Hassan I 'ila Souss*, p.50.
- ² - Al-Kanouni, *Asfi- Qadeḥan wa 'hadethan*, p. 57.
- ² - Al-Soussi, *khelāl jazwlat*, vol.2, p.191.
- ² - Ibn Zaydan, *Al-'iithāf*, vōl.2, p.251; Al-Mushrafī, *al'holal albahiāt*, vol.2, p. 163.
- ² - Al'iikrari, *Rawdat al'afnān*, p. 107.
- ² - Boumzko, *Tārekḥ almadīnaa*, p.31.
- ² - Ibn Zaydan, *Al-'iithāf*, vōl.2, p.247; Al-Mushrafī, *al'holal albahiāt*, vol.2, p. 160.
- ² - Elmi, *'Haraket alsultan Al-Hassan I 'ila Souss*, p. 56.
- ² - Ibn Zaydan, *Al-'iithāf*, vōl.2, p.251.
- ³ - Boumzko, *Tārekḥ almadīnaa*, p.31.
- ³ - Lahlou, Al-Idrisi, *Almo'hafaza 'ala aswār almodon al'ateqa*, p. 72.
- ³ - Monsieur, *Les remparts²des médinas*, p. 163.
- ³ - Al-Soussi, *khelāl jazwlat*, vol.2, p.191.
- ³ - Al'iikrari, *Rawdat al'afnān*, p. 69.
- ³ - Boumzko, Amerir, *Alm'aālem altarekheia*, p. 55.
- ³ - Al-Kanouni, *Asfi- Qadeḥan wa 'hadethan*, p. 57; Foucauld, *Reconnaissance au Maroc*, p. 344.
- ³ - Al-Kanouni, *Asfi- Qadeḥan wa 'hadethan*, p. 57.
- ³ - Al'iikrari, *Rawdat al'afnān*, p. 69.
- ³ - Amerir, *Mra'hel tatūr Tīznit*, p.21.
- ⁴ - The resources that chronicle for the city mentioned different measurements for the length of the wall, one mentioned that it was 7.5km. Boumzko, Amerir, *Alm'aālem altarekheia*, p. 55. And other estimated it with 5km. Bicard, *Les guides blues Maroc*, p. 219.
- ⁴ - Salem, *Adwā'a 'ala moḥkelat aswar 'Ishbellia*, p. 136.
- ⁴ - García, *Fábricas islámicas del mirador almohade*, p. 18; Azuar, *Las técnicas constructivas*, p. 154.
- ⁴ - Boumzko, Amerir, *Alm'aālem altarekheia*, p. 60.
- ⁴ - Boumzko, Amerir, *Alm'aālem altarekheia*, p. 60.
- ⁴ - Boumzko, Amerir, *Alm'aālem altarekheia*, p. 60.
- ⁴ - Boumzko, Amerir, *Alm'aālem altarekheia*, p. 60.
- ⁴ - Boumzko, Amerir, *Alm'aālem altarekheia*, p. 60.
- ⁴ - Boumzko, Amerir, *Alm'aālem altarekheia*, p. 60.
- ⁴ - Boumzko, Amerir, *Alm'aālem altarekheia*, p. 60.
- ⁴ - Boumzko, Amerir, *Alm'aālem altarekheia*, p. 60.
- ⁵ - Boumzko, Amerir, *Alm'aālem altarekheia*, p. 60.
- ⁵ - Tapia is a major building material in north Africa and Andalusia, it is a mixture of dust, sand, lime, gravel, stones and some other materials mixed all with water in different proportions, pour into a wooden board known as the box and is left to dry for making the wall, until the construction is complete. For more information on Tapia and its composition, proportions of its components, types, how it is built? its employees, its advantages and disadvantages. Back to: Aglan, *Al'amāl almemāria al'harbia le-Khierān Al'amery*, pp. 287-293; Abu Rehab, *Aswār madīnat Tāroudant*, pp. 102-107; Daza, Rodríguez, Ángel, *Tapial o fábricas*, pp. 562-584; García, Miguel, *El tapial en el área sevillana*, pp.135- 141; Sánchez, *El refugio en altura andalusí*, pp.6-8.
- ⁵ - bin Noman, *Albenā'a be-alturāb*, p. ٢٣.
- ⁵ - Ibn Khaldoun, *Almoqadēma*, vol. 2, pp. 866-867. For more back to: Burton, *Islamic Castles in Iberia*, p. 239; Azuar, *Las Técnicas Constructivas*, p. 133.
- ⁵ - Cuchí, *La técnica tradicional del tapia*, p. 163; García, *Fábricas islámicas*, pp. 20-21.
- ⁵ - Lamrani, *Alm'emār almābny be-alturāb*, p. ١٠٨.

-
- ⁵ - That labor was often from the prisoners of war or from the sons of the slaves. Ibn Zaidan, *almanzae allatif*, p. 131; Ignacio, *Participación de cautivos cristianos*, pp. 125-158.
- ⁵ - Bin Noman, *Albenā'a be-alturāb*, p. ٢٣.
- ⁵ - Lamrani, *Alm'emār almābny be-alturāb*, p. ١٠9.
- ⁵ - Bin Noman, *Albenā'a be-alturāb*, p. ٢٣.
- ⁶ - Salem, *Adwā'a*, pp. 152-153.
- ⁶ - Othman, *Almadīnaa al'islāmīa*, p. 146.
- ⁶ - Lapid, *Abraz almazahe²al'omrānya fī Alandalus*, p. 455.
- ⁶ - Crespo, *El debate de las³influencias orientales*, p. 401; Salem and others, *Al'amā'ar Alḥarbīa*, p. 666.
- ⁶ - Aglan, *Alqeshāb albāqea⁴fī al'andalus wa almaghreb*, p. 444.
- ⁶ - Ibn Mankal,; *al'heal fī al'hurūb*, p. 141.
- ⁶ - Maldonado, *'Emāret almōdon wa al'hoşūn*, vol.2, p. 8.